

Adapter

SA - Straight Adapters

RoHS compliant products are also available. Please contact us for details.



Some parts are available with standard threads. Contact us for details.

Dimensional drawing

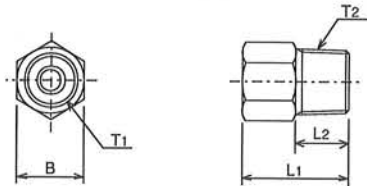

Model

Model	Part Number	Tubing O.D. (ϕ)	L ₁	L ₂	T ₁	T ₂	B
SA4-16	106001	4	16	8	M8×1	R1/8	10
SA4-20	106002		20	12			
SA4-25	106003		25	17			
SA4-30	106004		30	22			
SA4-35	106005		35	27			
SA6-20	206001	6	20	8	M10×1		12
SA8-25	207001	8	25	10	M14×1.5	R1/4	17

●Material : C3604

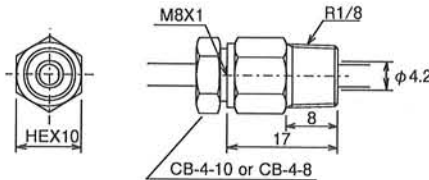

Model	Part Number	Tubing O.D. (ϕ)
SA-4K	106011	4

●Material : C3604

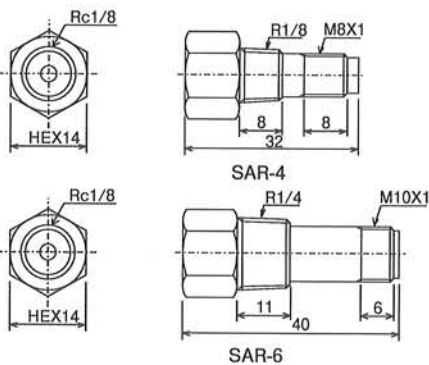

Model	Part Number	Tubing O.D. (ϕ)
SAR-4	106061	4
SAR-6	206223	6

●Material : C3604

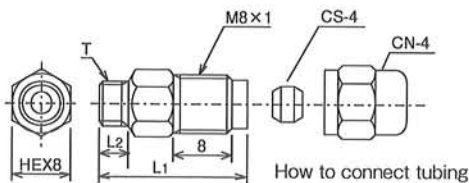

Model	Part Number	Tubing O.D. (ϕ)	L1s	L2	T
SAT-6A	106062	4	20	4	M6×1
SAT-6B	106065		23	7	M6×0.75

●Material : C3604

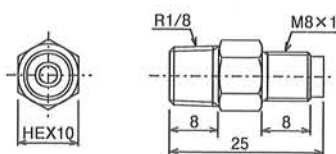

Model	Part Number	Tubing O.D. (ϕ)
SAT-1R	106081	4

●Material : C3604

Adapter

Elbow adapter/ T-adapter

RoHS compliant products are also available.
Please contact us for details.



Some parts are available with standard threads.
Contact us for details.

Dimensional drawing

EA

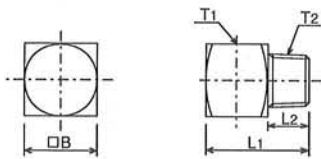

Model

Model	Part Number	Tubing O.D. (ϕ)	L ₁	L ₂	T ₁	T ₂	B
EA4-20	106021	4	20	8	M8×1	R1/8	14
EA4-25	106022		25	13			
EA4-30	106023		30	18			
EA4-40	106024		40	28			
EA4-50	106025		50	38			
EA4-60	106026		60	48			
EA4-2R	206091		25	11			
EA6-22	206092	6	22	8	M10×1	R1/8	16

●Material : C3604

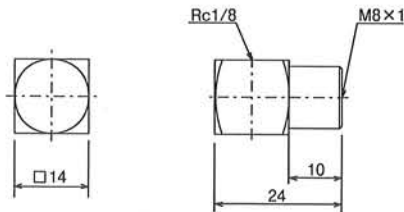

Model	Part Number	Tubing O.D. (ϕ)
EA4-1F	106031	4

●Material : C3604

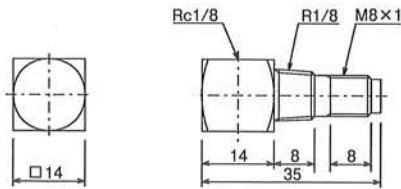

Model	Part Number	Tubing O.D. (ϕ)
EAR-4	106071	4

●Material : C3604

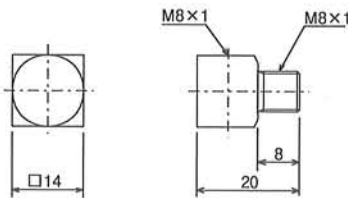

Model	Part Number	Tubing O.D. (ϕ)
EA4-8A	106029	4

●Material : C3604

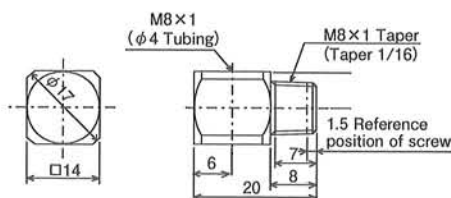

Model	Part Number	Tubing O.D. (ϕ)
EA4-8Taper	106037	4

●Material : C3604

RoHS compliant products are also available.
Please contact us for details.

Dimensional drawing

Model

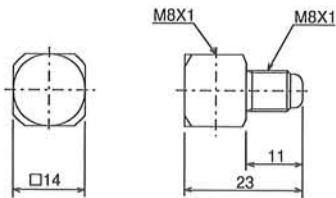

Model	Part Number	Tubing O.D. (ϕ)
EA4-8T	106028	4

●Material : C3604

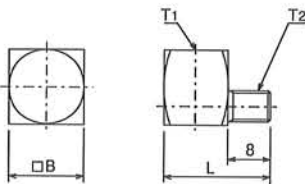

Model	Part Number	Tubing O.D. (ϕ)	L	T ₁	T ₂	B	Material
EA4-6A	106076	4	20	M8×1	M6×1	14	C3604
EA4-6AS	106074				SS330B		
EA4-6B	106075				M6×0.75		C3604
EA4-US	166036				1/4-28UNF		SUM-21
EA4-8B	166054				M8×1.25Taper		C3604
EA6-6AS	166048	6	22	M10×1	M6×1Taper	16	SUM-21
EA6-U	166040				1/4-28UNF		

Tubing Parts

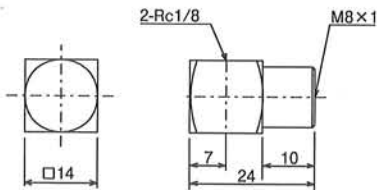

Model	Part Number
TA4-1F	106041

●Material : C3604

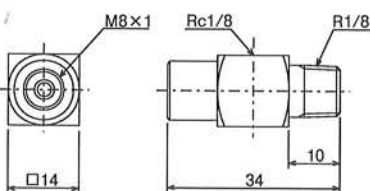

Model	Part Number
TAR-1F	106051

●Material : C3604